

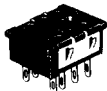

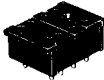















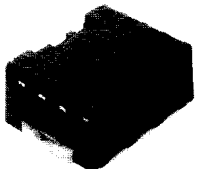

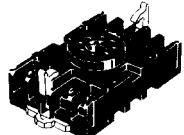
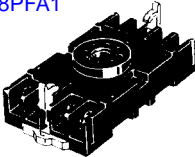

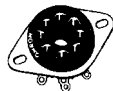
Modèles disponibles

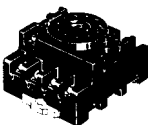
Modèles rectangulaires

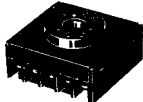
Modèle Nombre de broches	PYF (raccordement frontal)	PY (raccordement arrière)		Modèle Nombre de broches	PYF (raccordement frontal)	PT (raccordement arrière)	
		Broches à souder	Broch. circ. imprimé			Broches à souder	Broch. circ. imprimé
8 broches	PYF08A-E ▲ 	PY08 ▲ 	PY08-02 ▲ 	8 broches	PTF08A-E ▲ 	PT08 ▲ 	PT08-0 ▲ 
14 broches	PYF14A-E ▲ 	PYF14 ▲ 	PY14A-02 ▲ 	14 broches	PTF14A-E ▲ 	PT14 ▲ 	PT14-0 ▲ 

Modèle rond

Modèle Nombre de broches	PF (raccordement frontal)	P2CF (raccordement frontal)	PFA (raccordement frontal)	P3G (raccordement arrière)	PL (raccordement arrière)	
					Broches à souder	Brouches circuit imprimé
8 broches	PF083A-E ▲ 	P2CF-08 ▲ 	8PFA ▲  8PFA1 	P3G-08 ▲ 	PL08 ▲ 	PLE08-0 
11 broches	PF113A-E ▲ 	P2CF-11 ▲ 		P3G-11 ▲ 	PL11 ▲ 	PLE11-0 
14 broches			14PFA 			

▲ Produit classifié standard

Etriers de fixation

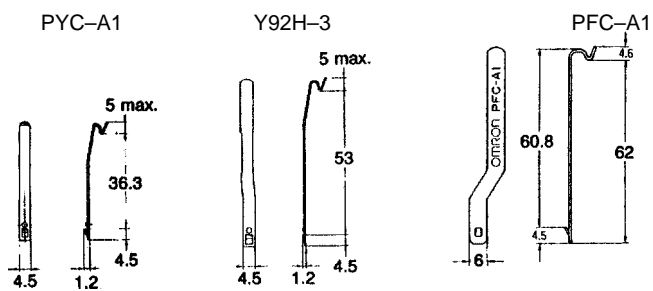

Compatibilité entre produits, socles et étriers

PYF08A-E	
Relais/minuterie	Etrier de fixation
série MY1	PYC-A1
série MY2	
H3Y-2	Y92H-3

PYF14A-E	
Relais/minuterie	Etrier de fixation
série MY4	PYC-A1
série MY2K	
H3Y-4	Y92H-3

PTF08A-E	
Relais	Etrier de fixation
série LY1 série LY2	PYC-A1

PTF14A-E	
Relais	Etrier de fixation
série LY4	PYC-A1

PF083A-E / PL08	
Relais	Etrier de fixation
MK2P-I MK2P-S MK2P(E)-US	PYC-A1

PF113A-E / PL11	
Relais/minuterie	Etrier de fixation
MK3P(5)-I MK3P(5)-S MK3P5(E)-US	PYC-A1
61F-GP-N H2C	-

8PFA1 / PL08	
Relais	Etrier de fixation
61F-GP G4Q	-

8PFA / PL08	
Relais/minuterie	Etrier de fixation
STP H3L	-

PF085A / PL08	
Minuterie	Etrier de fixation
H2C H3M ATSS H2A	-

14PFA	
Relais	Etrier de fixation
OPE-VX OPE-(V)A OPE-(V)B OPE-(V)C 61F-G1P 61F-G2P 61F-IP	-

P2CF-08 / P3G-08 / US-08	
Minuterie/compteur	Etrier de fixation
H3BA-8(H) H3BG-8(H) H3BF-8(H) H7CN H5CN E5C E2C-AM4A H3CA-8(H)	-

P2CF-11 / P3G-11	
Minuterie/compteur	Etrier de fixation
H3BA H3CA-A E2C-AK4A H7CN-..M H5CN-..M	-

Dimensions

PYF08A-E

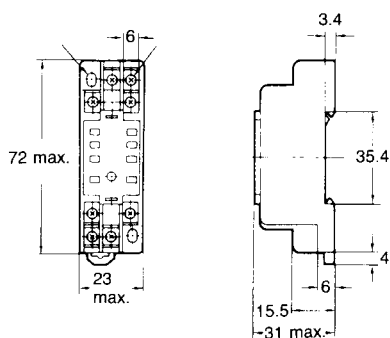

Raccordements

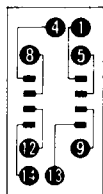

Trous de montage

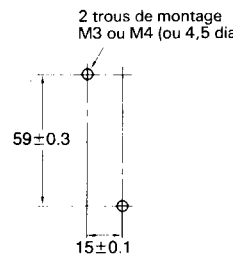

PYF14A-E

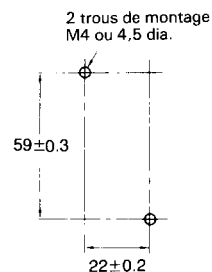
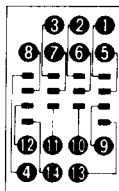
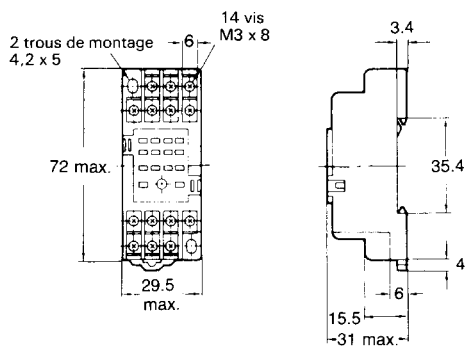

Rem. :
le socle peut être monté sur rail DIN

PTF08-A-E

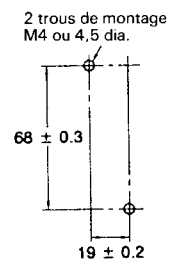
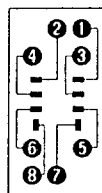
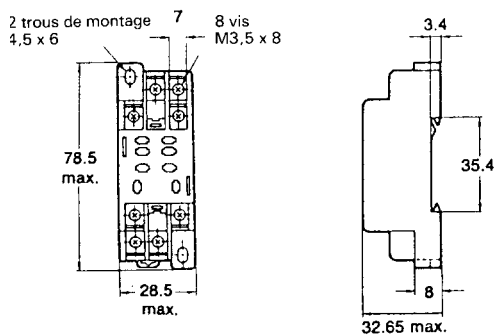

Rem. :
le socle peut être monté sur rail DIN

PTF14A-E

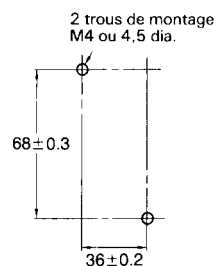
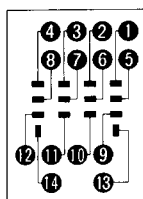
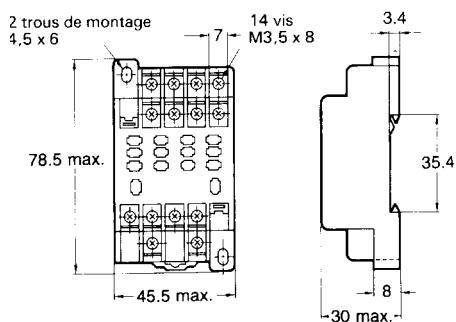

Rem. :
le socle peut être monté sur rail DIN

PF083A-E

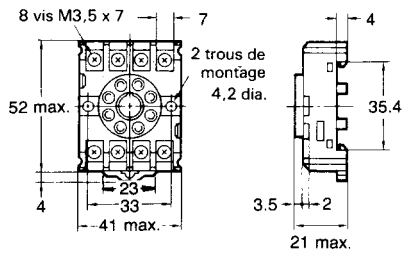

Raccordements

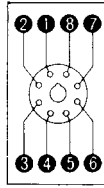

Trous de montage

2 trous de montage M4 ou 4,5 dia.

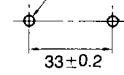

Rem. :

le socle peut être monté sur rail DIN

PF113A-E

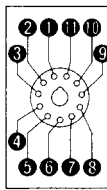
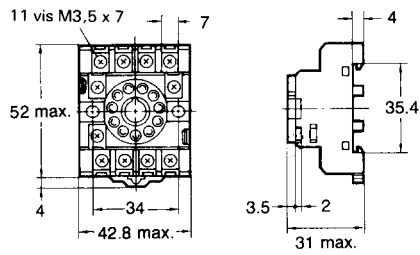

2 trous de montage M4 ou 4,5 dia.

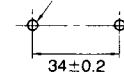

PY08

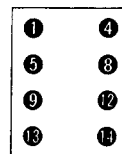
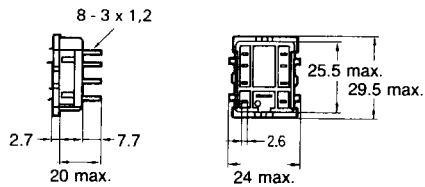

Vue de dessous

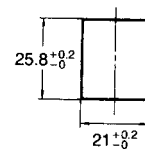

PY08-02

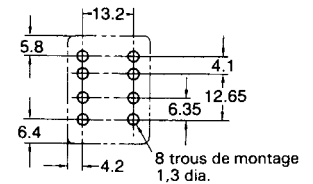
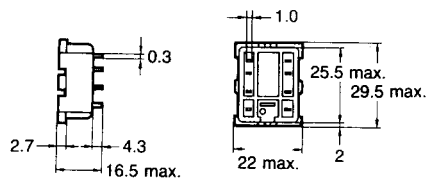

P2CF-08

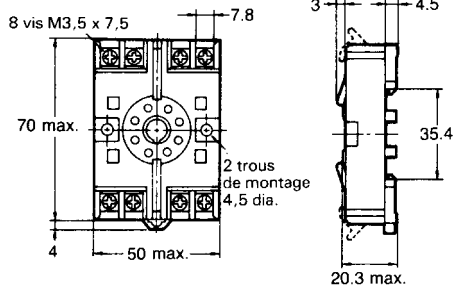

Raccordements

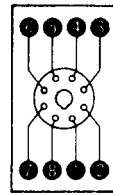

Vue de dessus

Trous de montage

2 trous de montage M4 ou 4,5 dia.

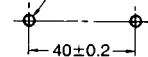

Note: Le socle peut être monté sur rail DIN

P2CF-11

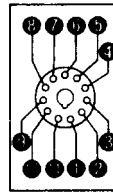
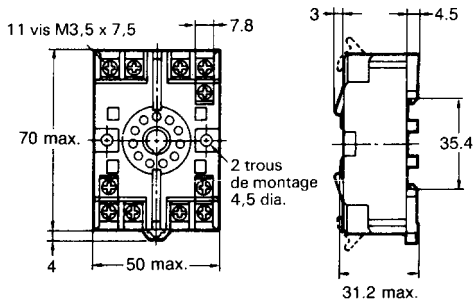

Vue de dessus

2 trous de montage M4 ou 4,5 dia.

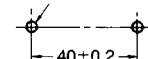

Note: Le socle peut être monté sur rail DIN

8PFA

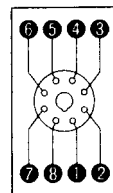
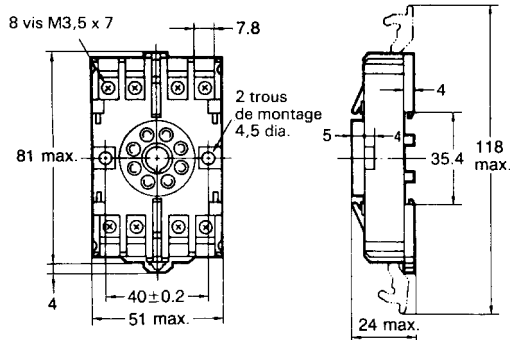

Vue de dessus

2 trous de montage M4 ou 4,5 dia.

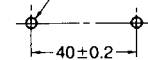

Note: Le socle peut être monté sur rail DIN

8PFA1

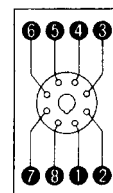
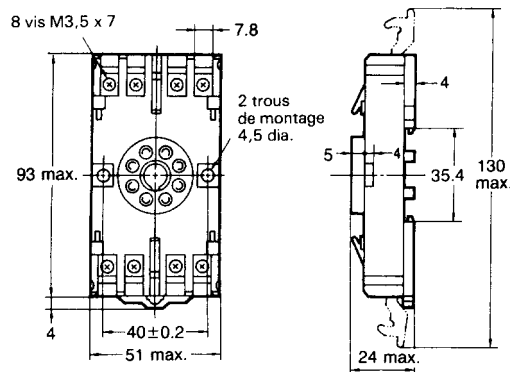

Vue de dessus

2 trous de montage M4 ou 4,5 dia.

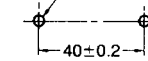

Note: Le socle peut être monté sur rail DIN

14PFA

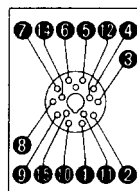
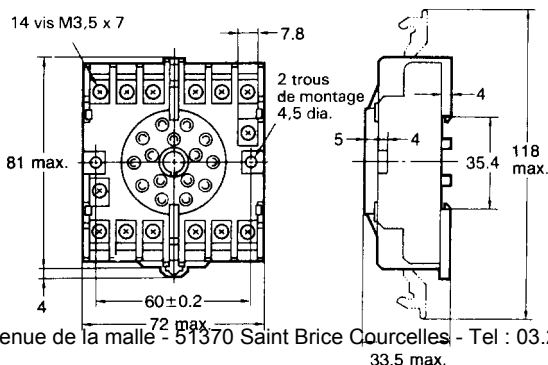

Vue de dessus

2 trous de montage M4 ou 4,5 dia.

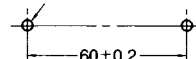

Note: Le socle peut être monté sur rail DIN

P3G-08

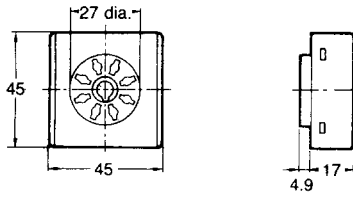

Raccordements

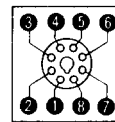

Trous de montage

Avec adaptateur modèle Y92F-30 (l=45)
0.5R max.

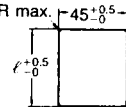

P3G-11

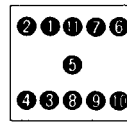
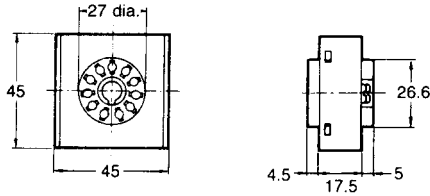

Vue de dessous

PL08

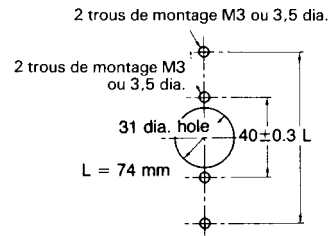
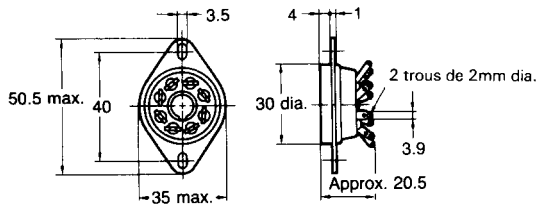

L = 74 mm.
STP, DTS, TDV
L = 86 mm.
61F-GP/-APN, G4Q-212

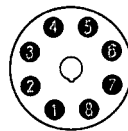

Vue de dessous

PLE 08-0

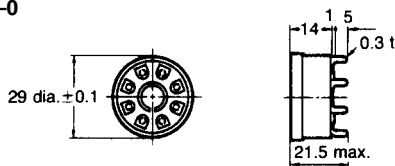

2 trous de montage 3,5 dia.
Trous de montage pour étrier de fixation

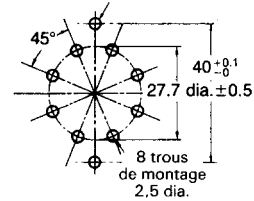

PL11

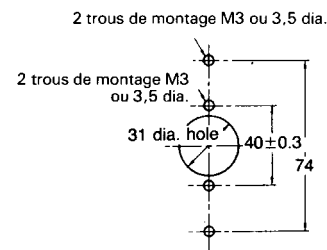
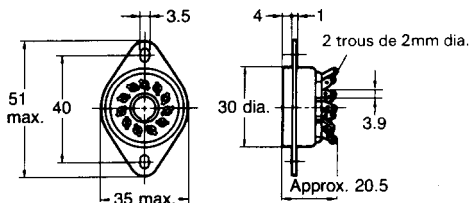

PLE11-0

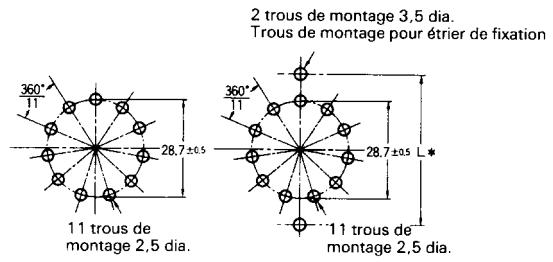
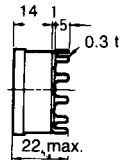
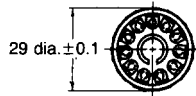

Dimensions des trous de montage pour modèle MK

Rail DIN et accessoires

Rail DIN

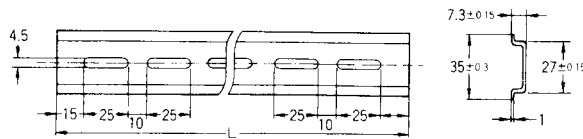
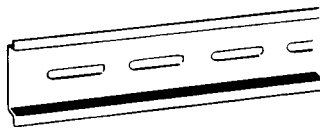

Rail DIN

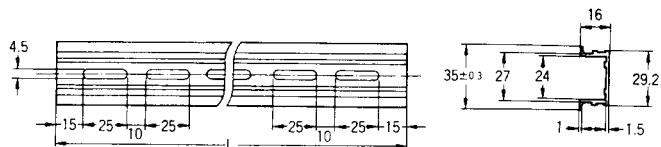
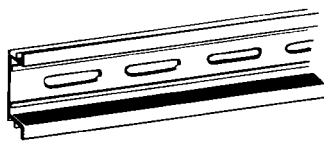

Butée

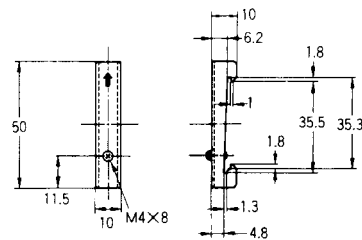
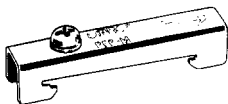

Entretoise

